

● **BLAUPUNKT**

2-WAY/3-WAY SYSTEMS

ICx 402



Enjoy it.

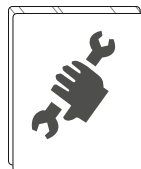

ENGLISH

Warranty

We provide a manufacturer's warranty for products bought within the European Union. For devices purchased outside the European Union, the warranty terms issued by our respective responsible domestic agency are valid. The warranty terms can be called up from www.blaupunkt.com.

Safety Notes

Please observe the following safety notes during the installation and connection.

- Disconnect the negative pole of the battery! Observe the safety notes of the vehicle manufacturer.
- When you drill holes, ensure that you do not damage any vehicle components.
- Use cable glands for holes with sharp edges.
- Leave ample clearance between the cables and other harnesses.
- An incorrect installation can result in malfunctions of the electronic vehicle systems or your car sound system.

Recycling and disposal



Please use the return and collection systems available to dispose of the product.

Subject to changes!

Installation

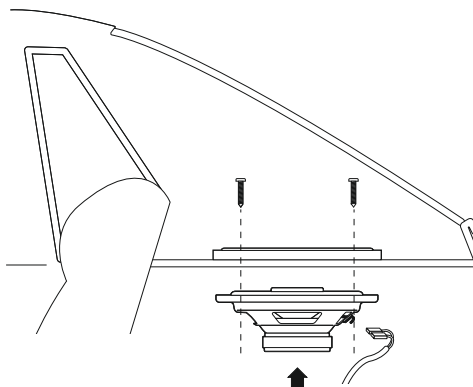

Technical data

ICx 402

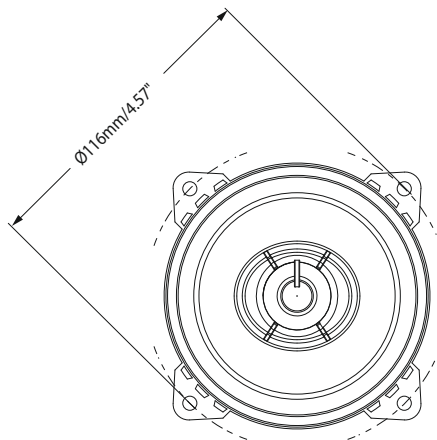
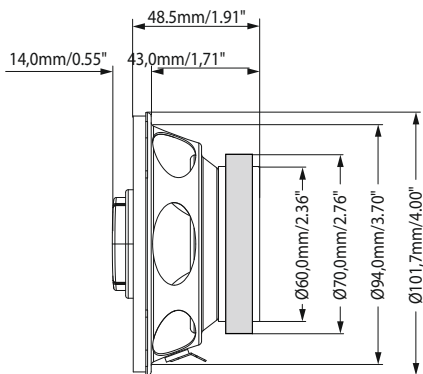

Performance ICx 402

Peak power handling	180 watts
RMS power handling	25 watts
Impedance	4 ohms
Frequency response	80-20,000 Hz
Sensitivity	90 dB (2.83 V/m)